



Kubota SVL75-3 Oil Cooler Cab Mount Kit

Installation Instructions

(Originating with Oil Cooler
Serial Number 108-101)

Model Number: _____
Serial Number: _____
Date of Purchase: _____



LOFTNESS SPECIALIZED EQUIPMENT, INC.

LIMITED WARRANTY POLICY

The limited warranty policy begins upon delivery of the unit to the original customers.

The following Loftness products have a two (2) year limited warranty;

XLB10 Grain Bag Loader, Battle Ax L-series Skid Steer, Battle Ax S-series Skid Steer, Battle Ax H-series Skid Steer, Battle Ax Excavator 20-series, Battle Ax Excavator 30-series, Battle Ax Excavator 40-series, Battle Ax Excavator 50-series, Battle Ax Extreme, Bad Ax Skid Steer, Timber Ax Skid Steer, Stump Ax, BT20, Kwik Cut.

All other Loftness products have a one (1) year limited warranty.

If any Loftness product is used as rental or leased equipment the limited warranty period is for only 30 days from the delivery date to the original customers.

Loftness Specialized Equipment, hereinafter referred to as LOFTNESS, a manufacturer of quality machinery since 1956, warrants new LOFTNESS machinery and/or attachments at the time of delivery to the original purchaser, to be free from defects in material and workmanship when properly set up and operated in accordance with the recommendations set forth in the LOFTNESS Operator's Manual.

LOFTNESS' liability for any defect with respect to accepted goods shall be limited to repairing the goods at an authorized dealer or other LOFTNESS designated location, or replacing them as LOFTNESS shall elect. The above shall be in accordance with LOFTNESS warranty adjustment policies.

WARRANTY REQUIREMENTS

Warranty registration form must be filled out and returned to Loftness Specialized Equipment to validate all warranty claims.

To receive a warranty claim, a return authorization from LOFTNESS must be obtained. The failed part may then be returned in an untampered status. This warranty does not include freight or delivery charges incurred when returning machinery for servicing. Dealer mileage, service calls and pick-up/delivery charges are the customer's responsibility.

LIMITATIONS OF WARRANTY

LOFTNESS products are designed to provide years of dependable service when proper use and maintenance is adhered to. The potential for misuse in many applications exists; therefore, a limited warranty is provided as follows.

This warranty shall not apply to any machine or attachment which shall have been repaired or altered outside the LOFTNESS factory or authorized LOFTNESS dealership or in any way so as in LOFTNESS' judgment, to affect its stability or reliability, nor which has been subject to misuse, negligence or accident, nor to any machine or attachment which shall not have been operated in accordance with LOFTNESS' printed instructions or beyond the company recommended machine rated capacity. LOFTNESS may elect to have an area representative evaluate the condition of the machine before warranty is considered.

In addition, this limited warranty provides no coverage for general wear or maintenance items, misuse, environmental conditions and/or contamination for which they were not designed or not intended, including but not limited to the following items;

Use of machine beyond its rated capacity, Conveyors, Improper knife replacement, Auger wear, Missing knives, Saw blades, Striking foreign objects, Brakes and brake pads, Lack of lubrication, Tires, Failures caused by running in an "out-of-balance" condition, Hydraulic hoses damaged by being caught in "pinch points" or by moving parts, and Damage caused by excessive force from the power unit.

EXCLUSIONS OF WARRANTY

Except as otherwise expressly stated herein, LOFTNESS makes no representation or warranty of any kind, expressed or implied. **The implied warranty of merchantability and fitness for a particular purpose are excluded from this limited warranty.** The remedies set forth in this warranty are the only remedies available to any person under this warranty. LOFTNESS shall have no liability to any person for incidental, consequential or special damages of any description, whether arising out of express or implied warranty or any other contract, negligence, or other tort or otherwise. This exclusion of consequential, incidental and special damages is independent from and shall survive any finding that the exclusive remedy failed of its essential purpose. Upon purchase, the buyer assumes all liability, all personal injury and property damage resulting from the handling, possession or use of the goods by the buyer.

No agent, employee or representative of LOFTNESS has any authority to bind LOFTNESS to any affirmation, representation or warranty concerning its machinery and/or attachments except as specifically set forth herein. (August 2023)

LOFTNESS ™

Table of Contents

Warranty

Table of Contents

Introduction

| | |
|---------------------------------------|---|
| Dealer/Owner Information | 7 |
| Dealer/Owner Responsibility | 7 |

Safety Instructions

| | |
|---------------------------------------------|---|
| Safety First | 8 |
| Safety Rules | 8 |
| Set-up Safety | 8 |
| Hoist (Lifting) Safety | 9 |
| Hydraulic Safety | 9 |
| California Proposition 65 Warning | 9 |

Options

| | |
|-------------------------------------------------------------|----|
| Universal Oil Cooler Kit (Kubota SVL75-3) Options | 10 |
|-------------------------------------------------------------|----|

Installation Instructions

| | |
|--------------------------------------------------------------------|----|
| Set-up | 12 |
| Disconnect Battery | 12 |
| Removing Panels and Air Intake | 12 |
| Adding the Cooler Kit Hydraulic Hose | 13 |
| Adding the Core Line Assembly | 15 |
| Adding Bulkhead Plate and Fittings | 15 |
| Mounting the Oil Cooler to the Cooler Mounting Frame | 16 |
| Mounting the Cooler Kit to the Cab | 17 |
| Temporarily Removing the Front Lights | 17 |
| Reinstalling the Front Lights | 18 |
| Oil Cooler Hydraulic Connections | 19 |
| Routing the Cooler Wiring Harness | 20 |
| Loftness Cooler Position Schematic (Wire Harness N68127) | 21 |
| Electrical Connections | 22 |
| Check and Verify Fan Operation | 22 |
| To Check Fan with Key On | 22 |
| Securing Hoses and Wiring Harness | 23 |
| Testing the Oil Cooler Cab Kit | 23 |
| Hydraulic Oil Level | 23 |
| Checking for Leaks | 23 |
| Reinstalling Covers and Panels | 23 |

Appendix

| | |
|-----------------------------------------|----|
| Torque Specifications | 24 |
| Inches Hardware and Lock Nuts | 24 |
| Metric Hardware and Lock Nuts | 25 |



Dealer/Owner Information

Some components of the Universal Hydraulic Oil Cooler Cab Mount Kit for the Kubota SVL75-3 are shipped disassembled and need to be removed from their shipping positions, assembled, and secured in their operating position before being delivered to the owner.

To ensure safe and proper set-up of the oil cooler cab mount kit, it is mandatory that you thoroughly study this manual and follow its recommendations and information. Proper assembly is essential to prevent injury or damage and to maximize the life of the oil cooler.

For specific operating and maintenance instructions, specifications, and serviceable parts for the Loftness Universal Oil Cooler, refer to the Owner's Manual that is shipped with each cooler, or visit www.loftness.com for an electronic file of the manual.

Keep all factory-installed track loader parts that will be replaced by any new Loftness Oil Cooler Cab Kit parts. Those parts will need to be reinstalled should the Oil Cooler Cab Kit ever need to be removed from your track loader.

Continuous improvement and advancement of Loftness products may result in changes to this equipment that may not be reflected in this publication. Loftness reserves the right to make product improvements to the oil cooler cab mount kit at any time. Although great care has been taken to ensure the accuracy of this publication, Loftness does not assume any liability for errors or omissions.

Dealer/Owner Responsibility

Assemble and set up the oil cooler cab mount kit in a safe manner and in accordance with all applicable local, state, and federal codes, regulations and/or laws, and in compliance with on-product labeling and these instructions.

Make sure that all personnel employed to set up and assemble the oil cooler cab mount kit:

- has read this manual and thoroughly understands safe and correct installation procedures.
- is familiar with the oil cooler and track loader.
- has a full understanding of the tools and/or equipment used to set up the oil cooler cab mount kit, such as hoists, power tools, etc.

Make sure the oil cooler cab mount kit is installed correctly before being placed into service.

Fulfill and assist the owner with all warranty obligations so as not to void the warranties. The warranty policy included in the Owner's Manual for the oil cooler outlines the warranty policy of Loftness.

Safety Instructions

Safety First

Accidents can be prevented by recognizing the causes or hazards before an accident occurs and doing something about them. Regardless of the care used in the design and construction of the oil cooler cab mount kit, there are some areas that cannot be safeguarded without interfering with accessibility and efficient operation.

| | |
|-----------------------------------------------------------------------------------|--------------------------------------------------------------------------------------------------------------------------------------------------------------------------------------------------------------------------------------------------------------|
|  | Safety Alert Symbol <p>This message alert symbol identifies important safety messages on the product and in this manual. When you see this symbol, be alert to the possibility of personal injury and carefully read the message that follows.</p> |
|-----------------------------------------------------------------------------------|--------------------------------------------------------------------------------------------------------------------------------------------------------------------------------------------------------------------------------------------------------------|

In this manual and on decals used on the oil cooler the words **DANGER, WARNING, CAUTION, IMPORTANT,** and **NOTE** are used to indicate the following:

DANGER: This word warns of immediate hazards which, if not avoided, will result in severe personal injury or death. The color associated with Danger is RED.



WARNING: This word refers to a potentially hazardous situation which, if not avoided, could result in severe personal injury or death. The color associated with Warning is ORANGE.

CAUTION: This word refers to a potentially hazardous or unsafe situation that, if not avoided, may result in minor or moderate injury. It may also be used to alert against unsafe practices. The color associated with Caution is YELLOW.

IMPORTANT: Highlights information that must be heeded.

NOTE: A reminder of other related information that needs to be considered.

If Safety Decals on the oil cooler are ISO two panel pictorial, decals are defined as follows:

- The first panel indicates the nature of the hazard.
- The second panel indicates the appropriate avoidance of the hazard.
- Background color is YELLOW.
- Prohibition symbols such as   and  if used, are RED.

Be certain all assemblers are aware of the dangers indicated by safety decals applied to the oil cooler, and be certain they follow all safety decal instructions. Contact Loftness for safety decal replacement.

Loftness cannot anticipate every possible circumstance that may involve a potential hazard. The warnings in this manual are not all inclusive.

Safety Rules

These are general safety considerations. Additional precautions may be necessary to set up the oil cooler cab mount kit in a safe manner. Be certain you are operating your equipment and tools in accordance with all safety codes, OSHA rules and regulations, insurance requirements and local, state, and federal laws while setting up this Loftness unit.

Set-up Safety

- Disconnect battery connections before beginning the installation.
- Do not allow anyone to set up and/or assemble the oil cooler cab mount kit until he or she has read the set-up manual and is completely familiar with all safety precautions.
- Become familiar with the safety decals on the oil cooler.
- Do not allow inexperienced persons unfamiliar with the track loader, or the tools/equipment used to set up the oil cooler cab mount kit, to perform any set up procedures.
- Do not allow persons under the influence of alcohol, medications, or other drugs that can impair judgment or cause drowsiness to set up the oil cooler cab mount kit.
- Make sure the set-up area is clear of any distracting objects. Keep work areas clean and free of grease and oil to avoid slipping or falling.

Safety Instructions

Safety Rules (Cont'd)

- Keep children, bystanders and other workers away from the unit while being set up.
- Wear safety glasses, ear protection, respirators, gloves, hard hats, safety shoes and other protective clothing when required.
- It is the dealer/owner's responsibility to be aware of work area hazards when assembling the oil cooler cab mount kit.
- Do not replace components or parts with other than factory-supplied parts. To do so may decrease the effectiveness of the oil cooler. If you notice any missing or damaged parts contact Loftness immediately.
- Never attempt to make any adjustments to the oil cooler cab mount kit if the engine is running or the key is in the "ON" position in the track loader. Before leaving the operator's position, disengage power to the track loader and remove ignition key.

Hoist (Lifting) Safety

During maneuvering and set-up, it is recommended that a power hoist, or lift, be used to lift the cooler cab mount kit assembly into the operating position.

- Make sure the lifting device (hoist or heavy equipment) is capable of lifting the specified parts and/or assemblies.
- All personnel must be properly trained and experienced lift operators.

Hydraulic Safety



WARNING: *Contact with high pressure fluids may cause fluid penetration and burn hazards. Fluid that is under pressure can penetrate body tissue. Fluid penetration can cause serious injury and possible death. If fluid is injected into the skin, seek medical attention immediately!*

- Always wear safety goggles or glasses when working on hydraulic system to avoid eye injury.
- The hydraulic system is under high pressure. Make sure all lines and fittings are tight and in good condition. These fluids escaping under high pressure can have sufficient force to penetrate skin and cause serious injury.
- Never check for leaks by using any part of your body to feel for escaping fluid.
- To prevent serious personal injury from escaping high pressure fluid, never attempt to inspect, service or disassemble any part of the hydraulic system until all pressure has been relieved from the system.

California Proposition 65 Warning



WARNING: *This product can expose you to Mineral Oil, which is known to the State of California to cause cancer. For more information, go to www.p65warnings.ca.gov.*

Options

Universal Oil Cooler Kit (Kubota SVL75-3) Options

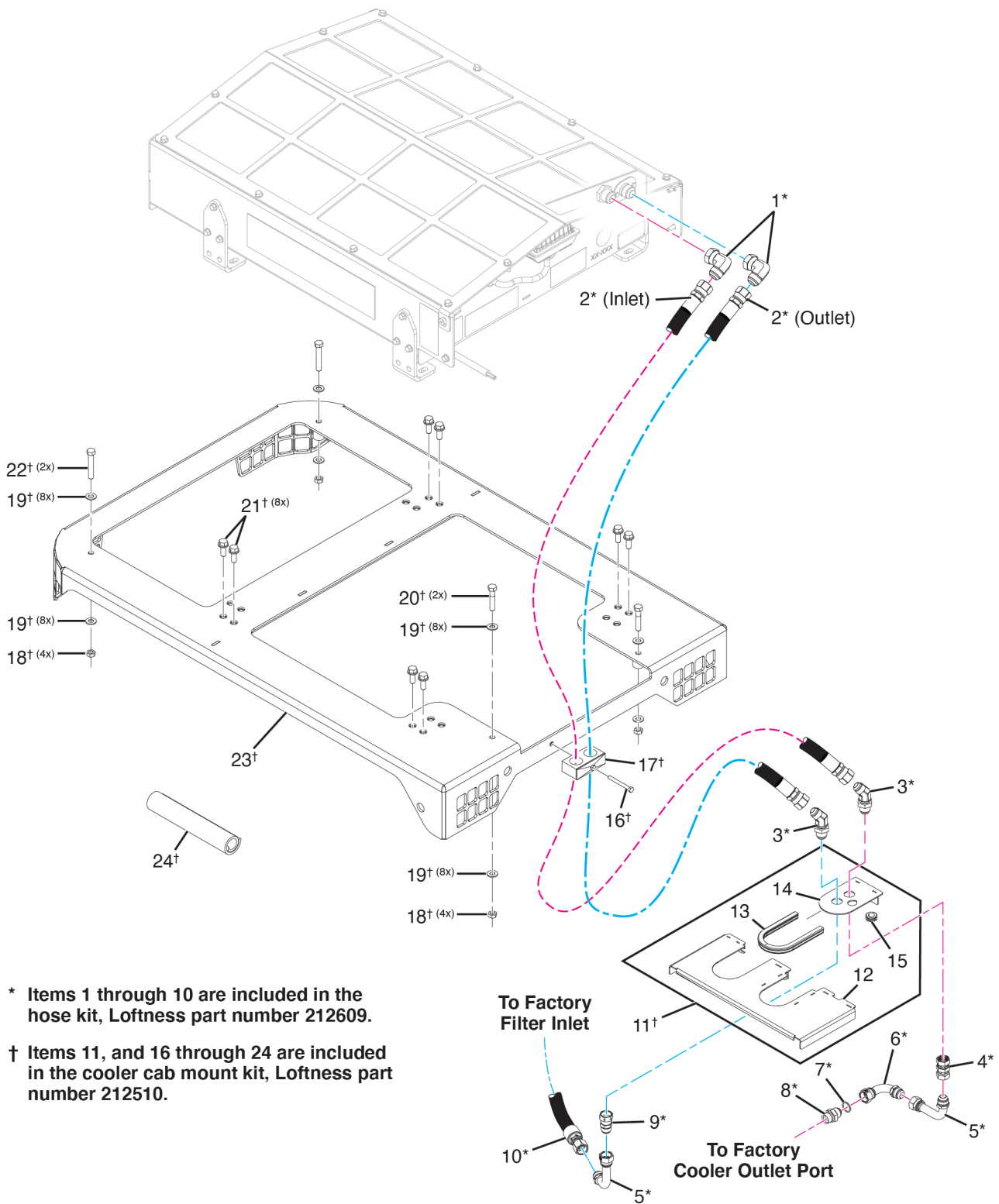

Universal Oil Cooler Kit (Kubota SVL75-3) Options

| # | QTY. | PART # | DESCRIPTION |
|-----|------|--------|---------------------------------|
| 1* | 2 | N19270 | ELBOW, 90 DEG - 16MJC - 16FJC |
| 2* | 2 | 212575 | HOSE, 3/4 X 60 -16FJIC -12FJIC |
| 3* | 2 | 202975 | ADAPTER, 45 BULKHEAD -12MJIC |
| 4* | 1 | N25884 | ADAPTER, 12FJIC - 12FJIC |
| 5* | 2 | N28906 | ELBOW, 90LG TUBE 12MJIC-12FJIC |
| 6* | 1 | N28902 | ELBOW, 90DG TUBE 12MJIC-12FJIC |
| 7* | 1 | 212571 | O-RING, 3/4 FOR BSPP THREAD |
| 8* | 1 | 212570 | ADAPTER, 12MJIC - 12MBSPP |
| 9* | 1 | N28841 | ADAPTER, 12MJIC - 12FJIC |
| 10* | 1 | 212697 | HOSE, 3/4 X 64 -12FJIC -12FBSPP |
| 11† | 1 | 212510 | KIT, KUBOTA SVL75-3 CFO |
| 12 | 1 | 212507 | COVER, KUBOTA SVL75-3 CFO |
| 13 | 1 | 212573 | TRIM, 7/16 PUSH-ON SEAL14.75L |
| 14 | 1 | 212506 | MOUNT, BULKHEAD KUBOTA SVL75-3 |
| 15 | 1 | N19297 | GROMMET-RUBBER |
| 16† | 1 | 4004 | BOLT, 5/16" X 3" GRADE 5 |
| 17† | 1 | N29662 | CLAMP, 1" HYD HOSE DOUBLE |
| 18† | 4 | 4054 | NUT, LOCK 1/2" TOP |
| 19† | 8 | 4068 | WASHER, 1/2" SAE FLAT |
| 20† | 2 | 4218 | BOLT, 1/2" X 2-1/2" GRADE 5 |
| 21† | 8 | N18360 | BOLT,1/2-13 X 1-1/4 SER FLG |
| 22† | 2 | 4016 | BOLT, 1/2 X 3 GRADE 5 |
| 23† | 1 | 212430 | WLDMT, KUBOTA SVL75-3 CAB MNT |
| 24† | 1 | 212432 | INSTRUCTIONS, KUBOTA COOLER MNT |

* Items 1 through 10 are included in the hose kit, Loftness part number 212609.

† Items 11, and 16 through 24 are included in the cooler cab mount kit, Loftness part number 212510.

Installation Instructions

Set-up

Park the track loader on a firm, flat and level surface.

Lower the lift arms to the ground and stop the engine.

| | |
|-----------------------------------------------------------------------------------|---------------------------------------------------------------------------------------------------------------------|
|  | WARNING: <i>Crushing hazard. Death or serious injury can result from falling lift arm and/or attachment.</i> |
|-----------------------------------------------------------------------------------|---------------------------------------------------------------------------------------------------------------------|

Shut down and lock out power to the track loader.

| | |
|-----------------------------------------------------------------------------------|----------------------------------------------------------------------------------------------------------|
|  | WARNING: <i>Failure to shut down and lock out power could result in serious injury, or death.</i> |
|-----------------------------------------------------------------------------------|----------------------------------------------------------------------------------------------------------|

NOTE: *Some procedures during the installation may be easier with the assistance of another person.*

Disconnect Battery

| | |
|-----------------------------------------------------------------------------------|--------------------------------------------------------------------------------------------------------------------------------------------------------------------------------------|
|  | CAUTION: <i>Disconnect battery connections before beginning the cab kit installation. Failure to do so could result in electric shock, fire, or damage to the oil cooler.</i> |
|-----------------------------------------------------------------------------------|--------------------------------------------------------------------------------------------------------------------------------------------------------------------------------------|

Removing Panels and Air Intake

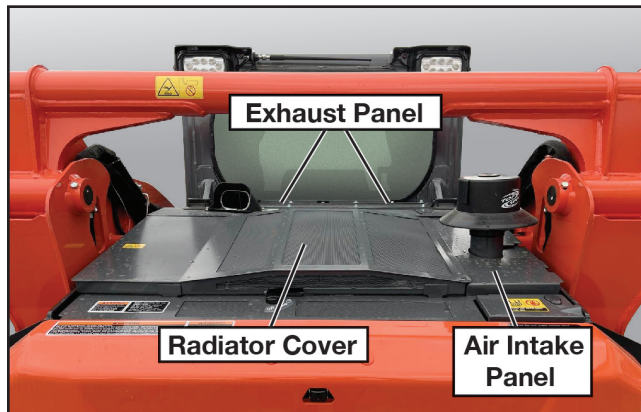

The panels and covers called out above will need to be removed from the track loader to begin the installation. Refer to your Kubota SVL75-3 owner's manual for removal instructions.

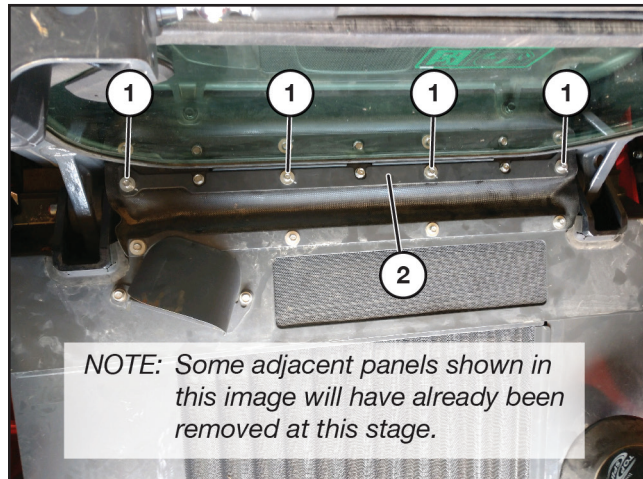

Remove the four bolts with washers (1) by the rear window and remove the panel (2).



Remove the air intake and the bracket as shown above. Refer to your Kubota SVL75-3 owner's manual for instructions.

Adding the Cooler Kit Hydraulic Hose

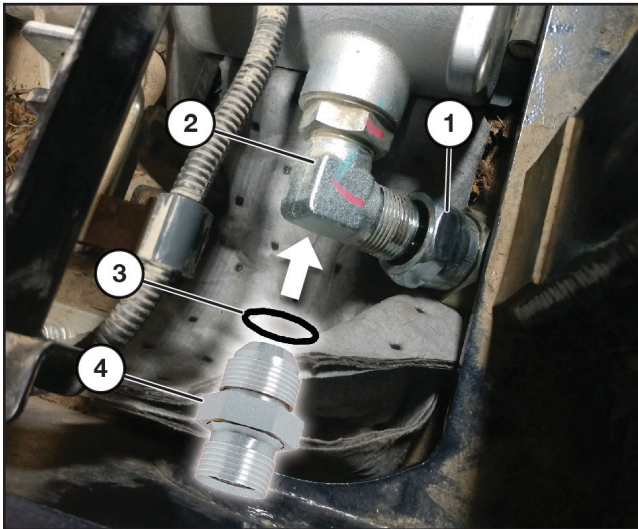

Disconnect the factory line (1) from the cooler core and remove the elbow (2).

Install the O-ring (3) - part no. 212571 onto the adapter fitting (4) - part no. 212570.

Insert the fitting (O-ring end first) into the cooler core and tighten. Add a temporary cap (-12JIC; not supplied) onto the new fitting.

Tilt the cab back into the maintenance position. Refer to your Kubota SVL75-3 owner's manual for instructions. Be sure to install the safety lock.

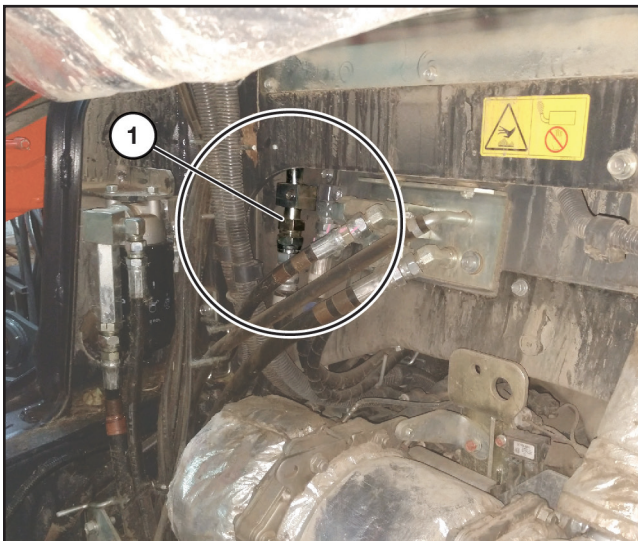

Locate the metal line (1) under the cab.

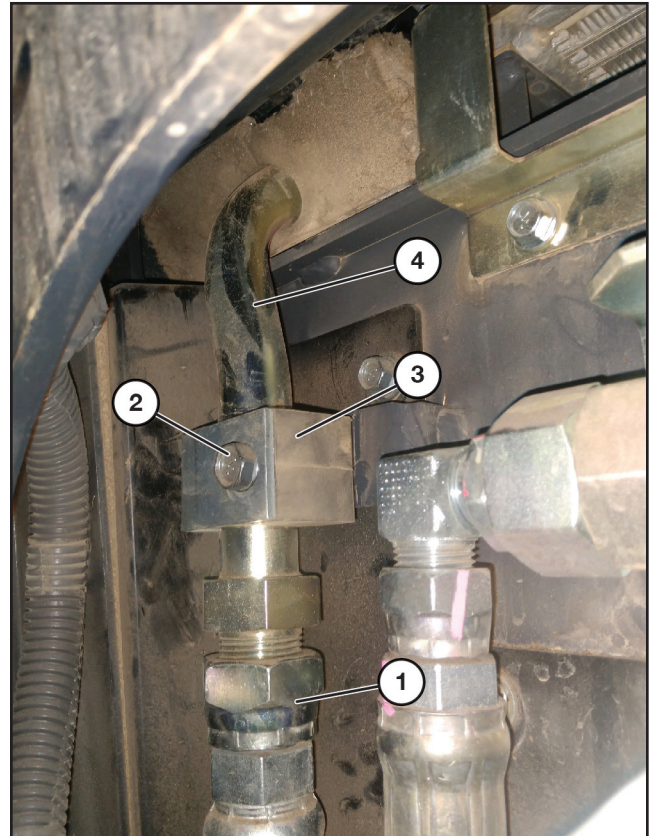

Disconnect the hydraulic hose (1).

Remove the bolt (2) securing the hose clamp (3), then remove the steel line (4) with clamp.

NOTE: Removing this line will cause hydraulic oil to drip.

(Procedure continued on following page.)

Installation Instructions

Adding the Cooler Kit Hydraulic Hose (Cont'd)

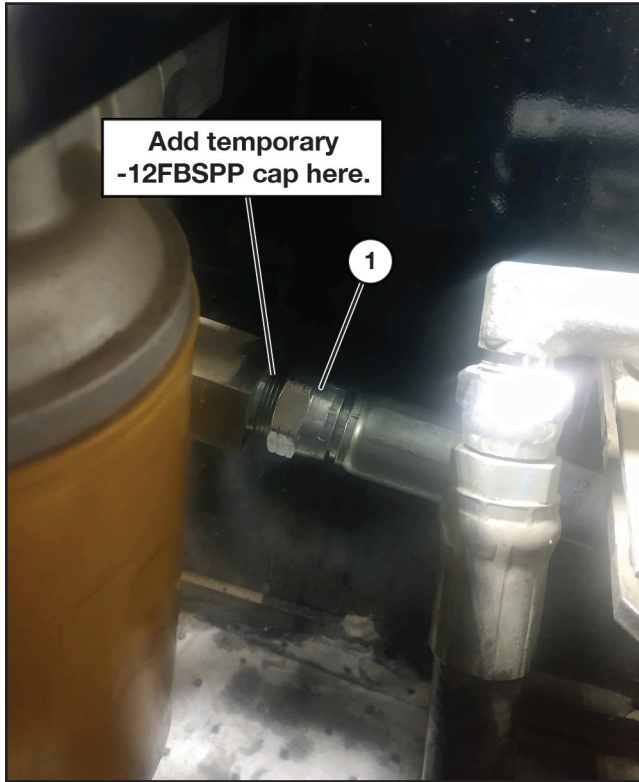

NOTE: Take note of the path/route of the Kubota factory hose and where it is secured. The new cooler kit hose will be installed in its place and will follow the same path.

Add a pan underneath the hydraulic connection at the filter assembly to catch any spilled oil.

Disconnect and remove the Kubota factory hose (1) from the filter assembly and install a cap (-12FBSPP; not supplied) onto the filter assembly fitting.

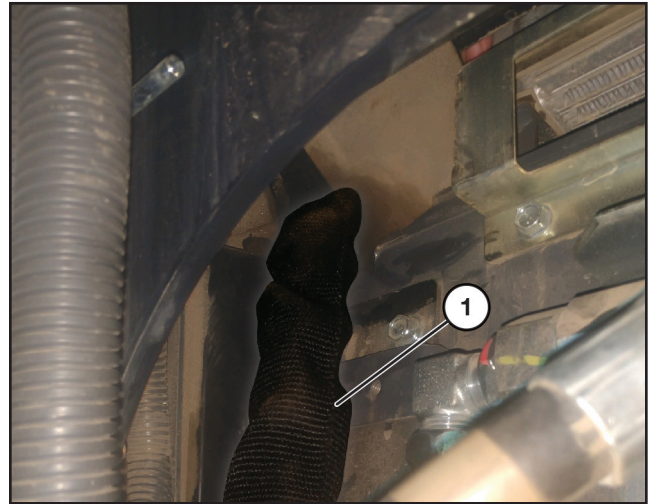

Route the new hydraulic hose (1) - part no. 212697 using the same path as the Kubota hose and steel line that was just removed.

IMPORTANT: Make hydraulic hose connections in the order written in the following procedure.

Connecting Lower End of Hose (Filter Connection)

Remove the temporary cap from the filter assembly fitting and connect the lower end of the hose to the filter assembly. Tighten.

Connecting Upper End of Hose

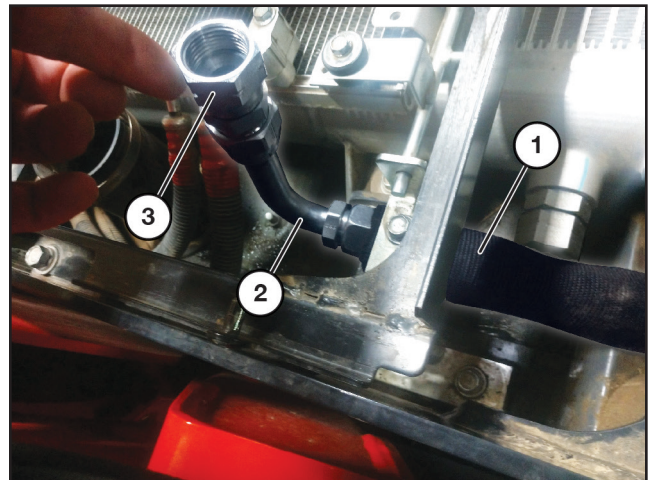

Connect the upper end of the hydraulic hose (1) to the elbow tube (2) - part no. N28906 with adapter fitting (3) - part no. N28841 from the cooler kit. Tighten in the vertical orientation as shown.

Installation Instructions

Adding the Core Line Assembly

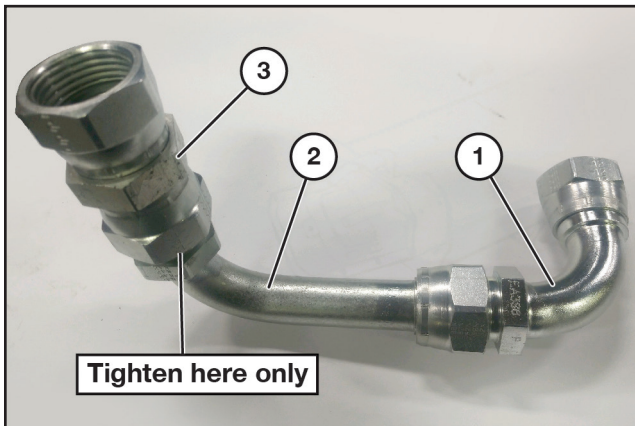

On a work bench, lay out and assemble the short elbow tube (1) - part no. N28902, long elbow tube (2) - part no. N28906, and union fitting (3) - part no. N25884.

IMPORTANT: Only tighten the union fitting (3). The 90° elbow tubes will be tightened when leveling the bulkhead.

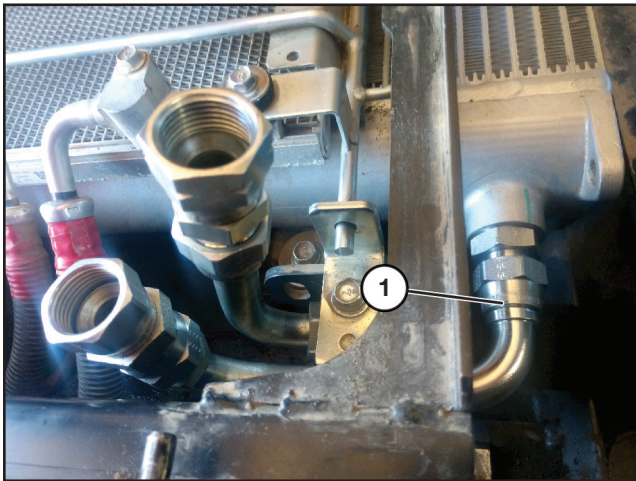

Remove the temporary cap on the core fitting and install the tube assembly (1) as shown. Do not tighten the fittings yet.

NOTE: This core tube assembly will sit above the tank line assembly.

Adding Bulkhead Plate and Fittings

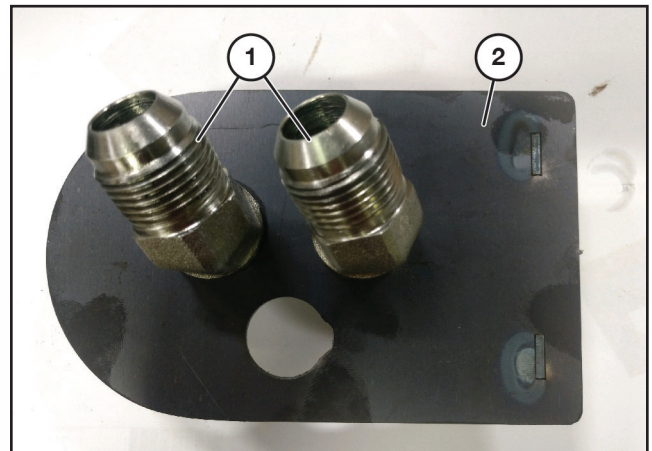

Install the two bulkhead fittings (1) - part no. 202975 at 45° onto the bulkhead plate (2) - part no. 212506 as shown.

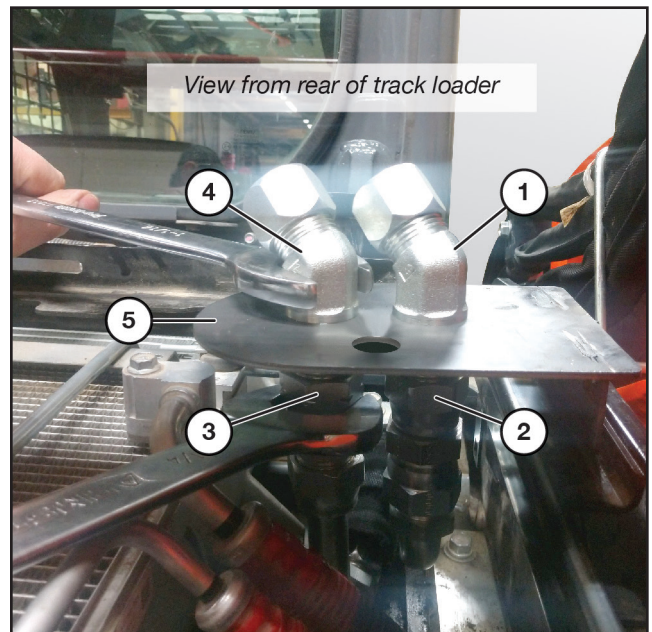

Connect the core assembly line (1) to the outside 45° bulkhead fitting (2), then connect the tank line union (3) to inside 45° bulkhead fitting (4)

Hold the bulkhead fittings when tightening the hydraulic lines, ensuring the bulkhead plate (5) remains level.

Install caps (-12JIC; not supplied) onto the two bulkhead fittings.

(Procedure continued on following page.)

Installation Instructions

Adding Bulkhead Plate and Fittings (Cont'd)

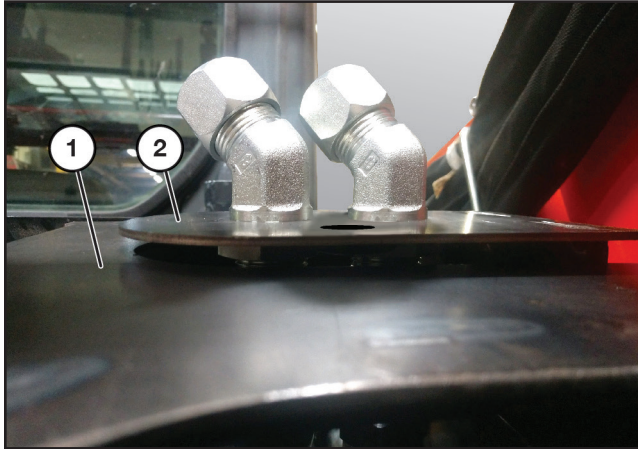

Temporarily set the cover panel (1) - part no. 212507 into position and check to make sure the bulkhead plate (2) is level with the cover panel.

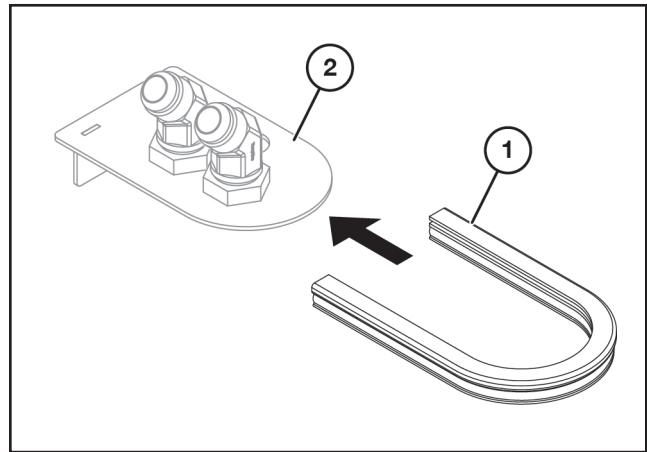

Install the seal trim (1) - part no. 212573 onto the bulkhead plate (2).

Mounting the Oil Cooler to the Cooler Mounting Frame

NOTE: The cab on the track loader must be in the operation position during this procedure. If the cab is tilted back into the maintenance position, lower back down.

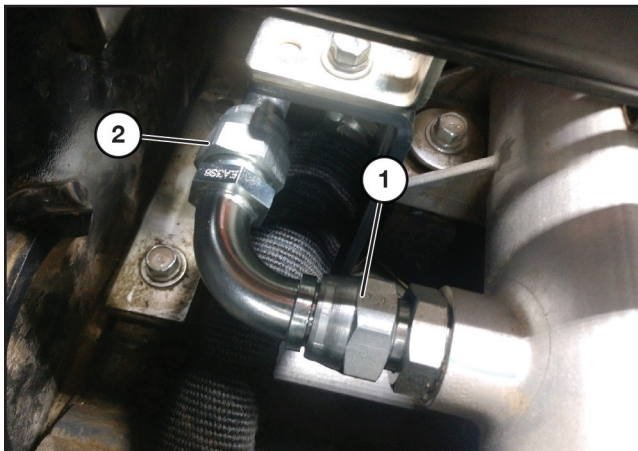

When level, tighten the core swivel fitting (1) first, then tighten the tube assembly swivel fitting (2).

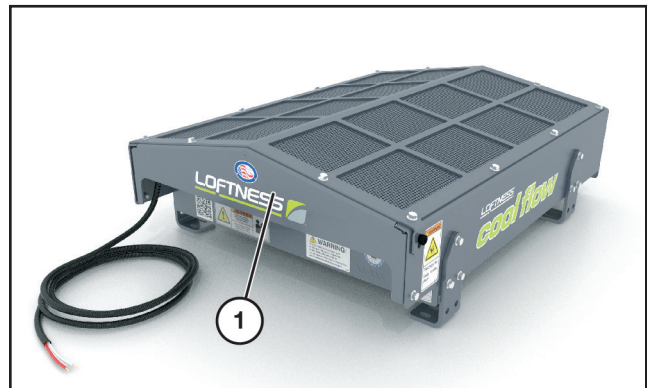

While the oil cooler is still on the ground, remove the back cover (1). This allows for easier access to the hydraulic fittings when connecting the hydraulic hoses.

(Procedure continued on following page.)

Installation Instructions

Mounting the Oil Cooler to the Cooler Mounting Frame (Cont'd)



Using a hoist, lift the oil cooler and place on top of the cooler mounting frame. Align the slotted holes in the mounting brackets to the holes in the mounting frame.

Secure using 1/2"-13 x 1-1/4" bolts (1) supplied with the kit. Two bolts at each bracket (8 total).

Mounting the Cooler Kit to the Cab

Temporarily Removing the Front Lights

NOTE: The front lights will need to be temporarily removed to access two holes used to secure the cooler kit. They will be reinstalled when the mounting is complete so keep in mind the order and orientation when removing.

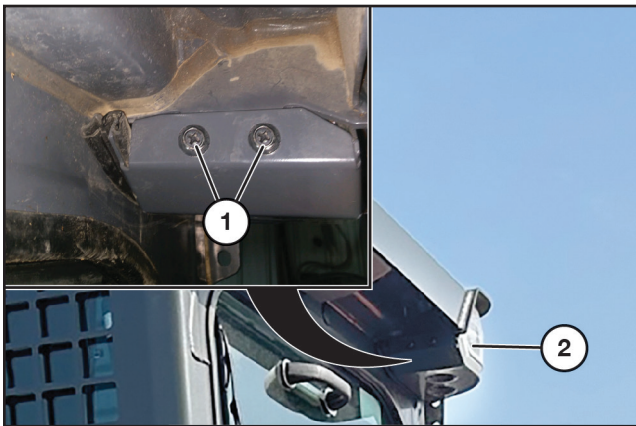

Remove the two inner bolts (1) securing the front left side headlight (2).

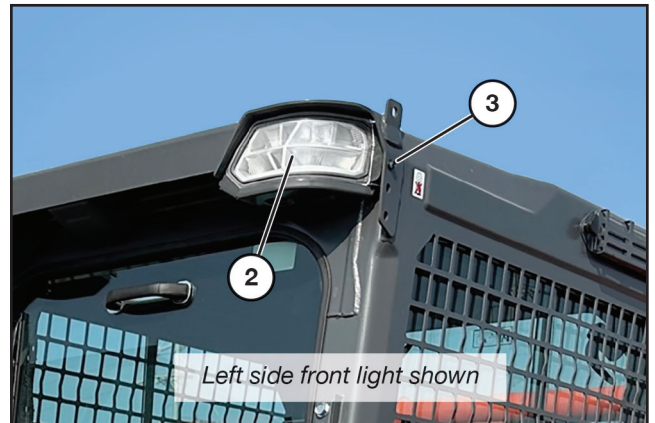

While supporting the light (2), remove the outer bolt (3).

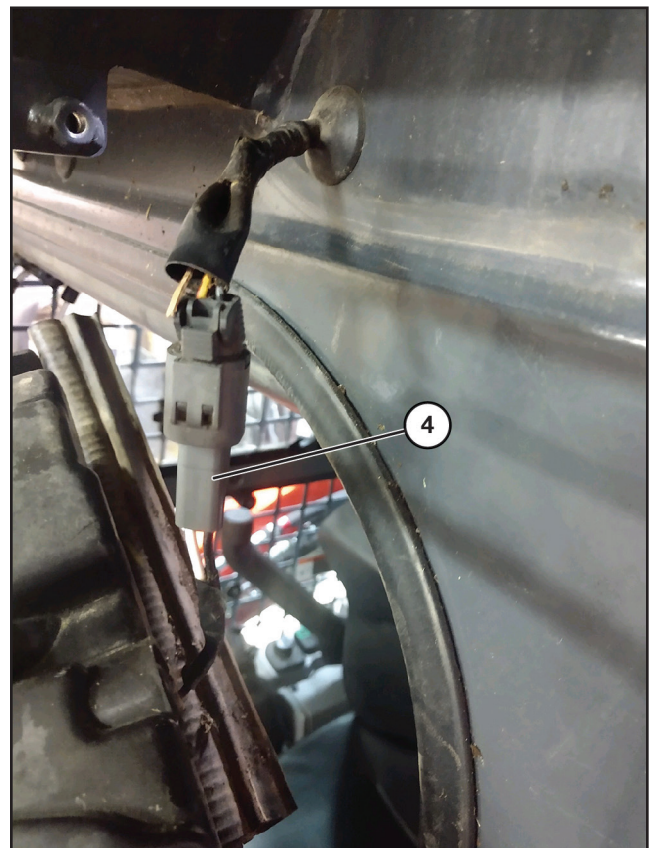

Disconnect the headlight wiring harness (4) and carefully remove the light. Set aside.

Repeat the procedure on the front right side headlight.

Installation Instructions

Mounting the Cooler Kit to the Cab (Cont'd)

 **WARNING:** The cooler mounting frame and oil cooler are heavy. Use a power hoist to lift and place the assembly into position. Failure to do so could result in serious injury, or death.

Ensure the antenna on the rear of the cab is folded down.



Lift the cooler kit and place into position on top of the track loader cab.

Align the holes in the cooler mounting frame with the holes on the cab.

NOTE: Before installing the mounting hardware, refer to the exploded view on page 10 for reference.

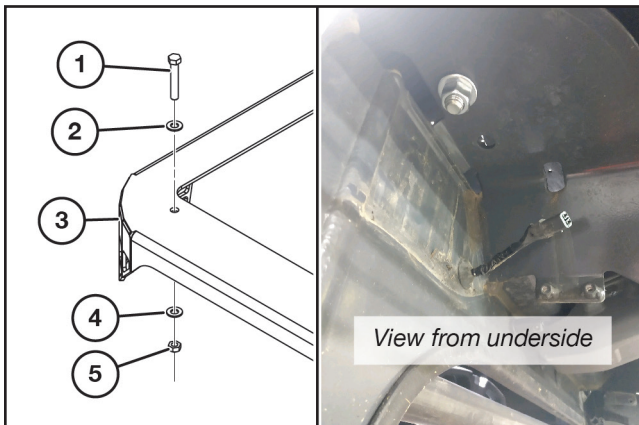

When the front holes are aligned, insert a bolt (1) - part no. 4016 with washer (2) - part no. 4068 from the top side of the cooler mount (3).

From the underside of the cab frame, install a washer (4) - part no. 4068 and nut (5) - part no. 4054 onto the bolt. Hand tighten the hardware.

Repeat the procedure on the opposite side of the cooler mounting frame.

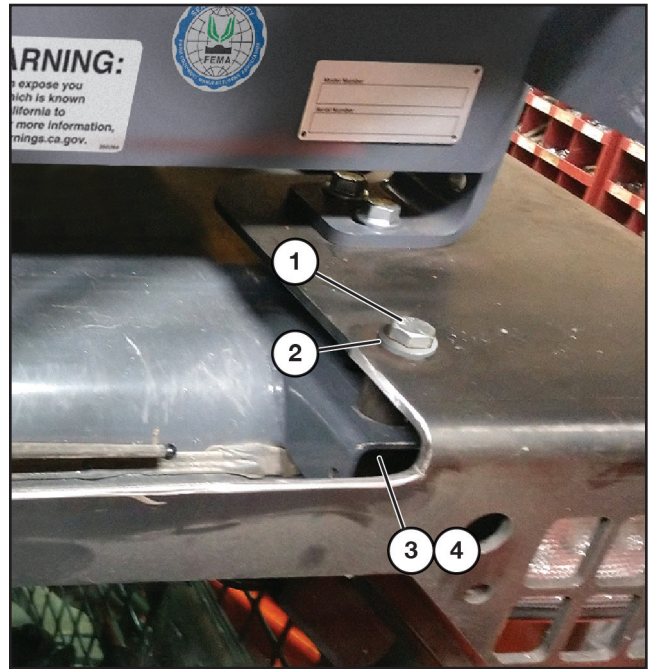

When the holes adjacent to the rear cab lights are aligned, insert a bolt (1) - part no. 4218 with washer (2) - part no. 4068 from the top side of the cooler mounting frame as shown above.

From the underside of the bracket on the cab, install a washer (3) - part no. 4068 and nut (4) - part no. 4054 onto the bolt. Hand tighten the hardware.

Repeat the procedure on the opposite side of the cooler mounting frame.

IMPORTANT: Before tightening the hardware, push the cooler mounting frame towards rear of cab.

Tighten the mounting hardware at all four locations.

Reinstalling the Front Lights

Return the front lights back into position. Connect the wiring harnesses and reinstall all hardware.

Installation Instructions

Oil Cooler Hydraulic Connections

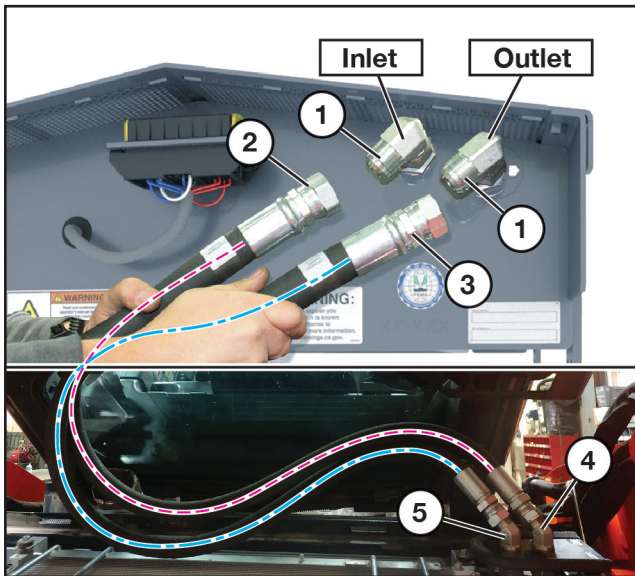

Connect the two elbow fittings (1) - part no. N19270 to the oil cooler INLET and OUTLET ports and position at the angle shown above.

Connect one end of the INLET hose (2) - part no. 212575 supplied with the kit to the INLET fitting on the oil cooler. Tighten.

Connect one end of the OUTLET hose (3) - part no. 212575 supplied with the kit to the OUTLET fitting on the oil cooler. Tighten.

NOTE: *Keep hoses to the left-rear corner of the cab. They will be secured later. Avoid any potential pinch points or sharp turns that could cut or wear on the hoses or wiring harness.*

Remove the caps from the bulkhead fittings.

Connect INLET hose (2) to right side bulkhead fitting (4). Do not tighten.

Connect OUTLET hose (3) to left side bulkhead fitting (5). Do not tighten.

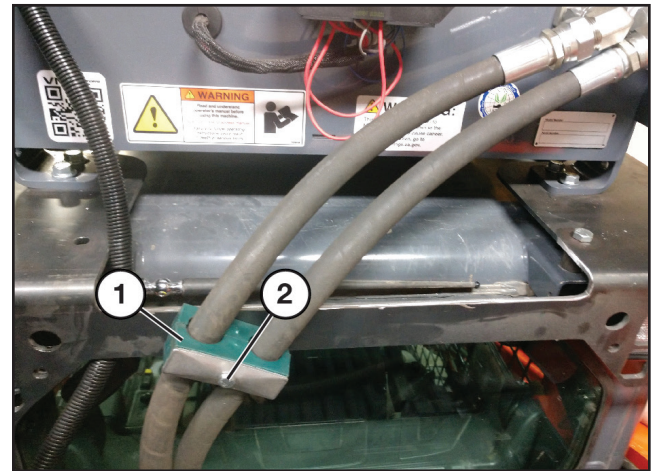

Install the hose clamp (1) - part no. N29662 and route hoses as shown above. Install the clamp bolt (2) - part no. 4004. Do not tighten at this time.

NOTE: *When complete, refer to the exploded drawing on page 10 to verify hose routing and connections*

Tilt the cab back into the maintenance position and tighten hose fittings at the bulkhead plate.

Tighten the hose clamp bolt.

Installation Instructions

Routing the Cooler Wiring Harness

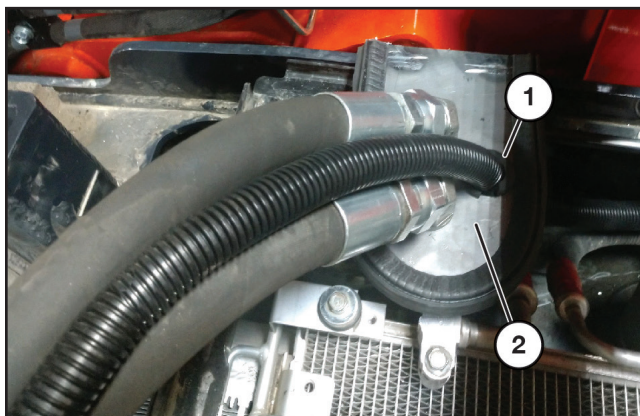

Route the cooler harness alongside the cooler hoses and through the bulkhead plate. Make sure to provide enough slack in the harness to avoid binding and pinch points when tilting the cab.

Cut the grommet (1) - part no. N19297 and wrap around the harness. Insert the grommet into the hole on the bulkhead plate (2).

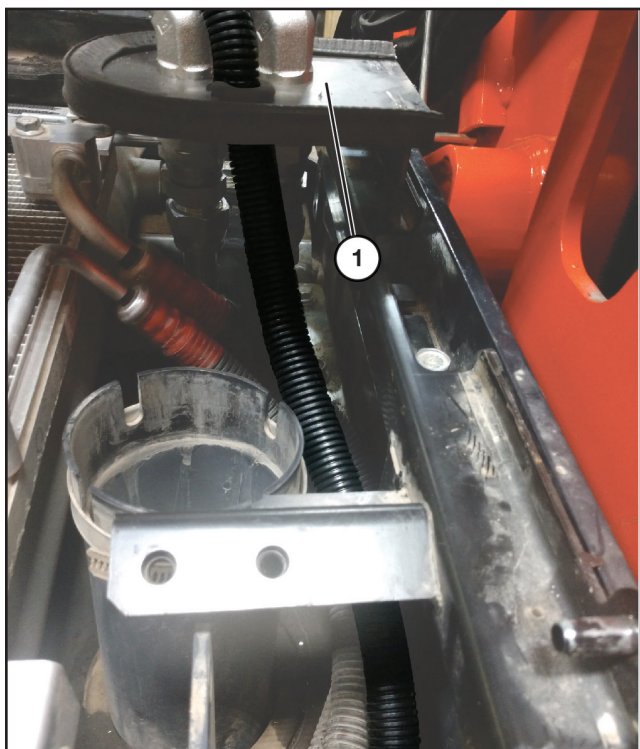

From the bulkhead plate (1), route the cooler harness alongside the track loader harnesses adjacent to the air intake as shown.

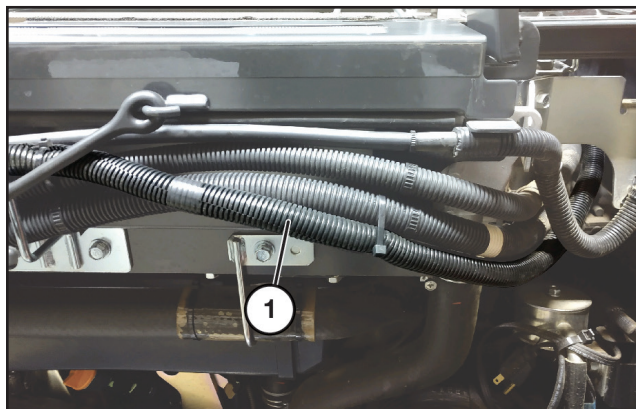

Continue routing the cooler harness (1) below the factory track loader's harnesses and to the left side of the track loader as shown.

NOTE: Routing the cooler harness outside or above the track loader's harnesses may prevent the engine compartment door from closing.

Use zip-ties to keep the harness in place.

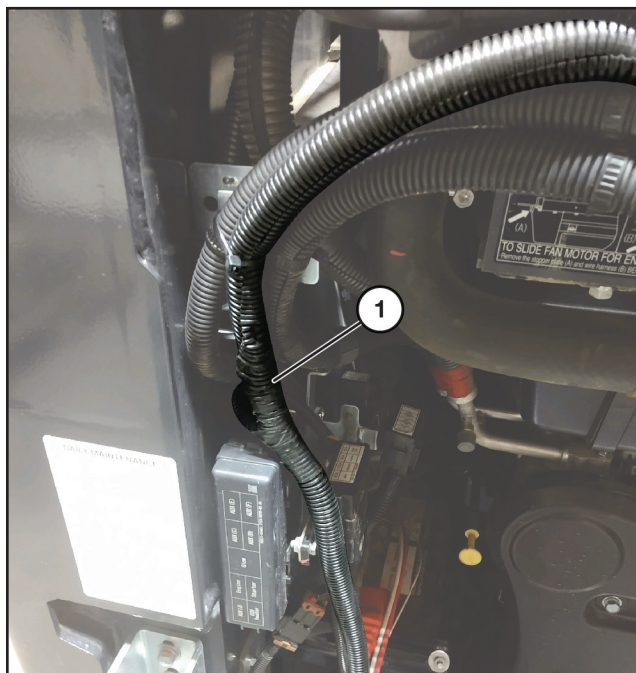

Route the cooler harness (1) end down towards the battery.

NOTE: Close the engine compartment door to check for clearance.

Add zip ties here to secure the harness.

Installation Instructions

Electrical Connections

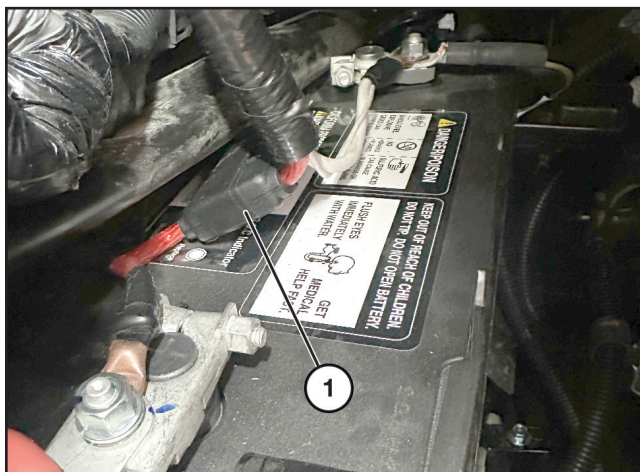

Connect the fuse holder (supplied with the oil cooler) to the red (8 AGW) wire from the cooler harness, and to the battery positive.

Connect both white wires (8 AGW and 18 AGW) from the cooler harness to battery ground.

Connect the orange wire (18 AGW) from the cooler harness to a keyed power location on the track loader.

NOTE: Refer to your Kubota SVL75-3 owner's manual or your dealer for a keyed power location.

Ensure the track loader's battery connections are reconnected properly.

Check and Verify Fan Operation

To Check Fan with Key On

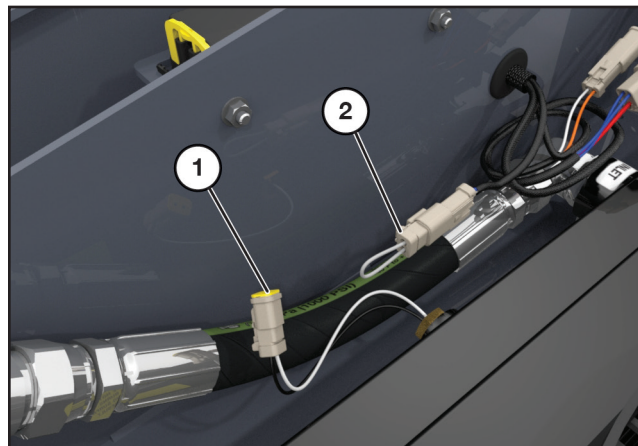

Remove the temperature sensor plug (1) on the main harness.

Use a jumper wire or Deutsch plug jumper (2) (dealer-made) to activate the fan. Fan will activate in 25-30 seconds.

Preset 120° F temperature setting is non-adjustable.

When test is complete, remove the jumper wire and reconnect the temperature sensor plug to the main harness.

Installation Instructions

Securing Hoses and Wiring Harness

Make sure the oil cooler hydraulic hoses and wiring harness are secure throughout. Use zip ties to secure where needed.

Avoid any potential pinch points or sharp turns that could cut or wear on the hoses or wires.

Make sure to tilt the cab back down into the operating position.

Testing the Oil Cooler Cab Kit

Ensure the oil cooler cab kit is completely and correctly installed. Ensure all hydraulic and wiring connections are tightened and secure.

Reinstall the air intake

Start the track loader and let run for about 30 seconds, then shut down.

Hydraulic Oil Level

After the oil cooler cab mount kit installation is complete, hydraulic oil will need to be added back into the hydraulic system.

Refer to your Kubota SVL75-3 Owner's Manual for adding hydraulic oil, keeping in mind that the oil cooler cab mount kit is shipped without hydraulic oil. This addition to the hydraulic system will need to be taken into consideration when filling.

Checking for Leaks

Once the hydraulic oil level is fulfilled, start track loader and test for leaks.



WARNING: Contact with high pressure fluids may cause fluid penetration and burn hazards. Fluid that is under pressure can penetrate body tissue. Fluid penetration can cause serious injury and possible death. If fluid is injected into the skin, seek medical attention immediately! Refer to "Hydraulic Safety" on page 9 for hydraulic safety warnings.

Reinstalling Covers and Panels

Shut down and lock out power to the track loader.



WARNING: Failure to shut down and lock out power could result in serious injury, or death.

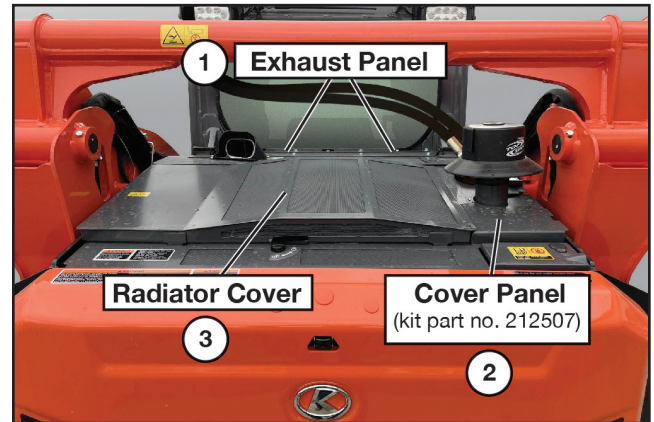

Reinstall the exhaust panel (1) first. Then install the cover panel (2) - part no. 212507 from the Loftness cooler kit. The radiator cover (3) is reinstalled last.

NOTE: Refer to your Kubota SVL75-3 owner's manual for assembly instructions.

Place the rear cover back onto the Loftness oil cooler. Reinstall the bolts and tighten.

Appendix

Torque Specifications

Inches Hardware and Lock Nuts

TORQUE CHARTS
 Minimum Hardware Tightening Torques
 Normal Assembly Applications
 (Standard Hardware and Lock Nuts)

| SAE Gr. 2 | SAE Grade 5 | | SAE Grade 8 | | LOCK NUTS | | | |
|-----------|---------------------------|-----------------------|---------------------------|------------------------|---------------------------|-------------------------|-----------------------|-----------------------|
| | Unplated or Plated Silver | Plated W / ZnCr Gold | Unplated or Plated Silver | Plated W / ZnCr Gold | Unplated or Plated Silver | Plated W / ZnCr Gold | Grade W / Gr. 5 Bolt | Grade W / Gr. 8 Bolt |
| 1/4 | 55 in.-lb. (6.2 N•m) | 72 in.-lb. (8.1 N•m) | 86 in.-lb. (9.7 N•m) | 112 in.-lb. (12.6 N•m) | 121 in.-lb. (13.6 N•m) | 157 in.-lb. (17.7 N•m) | 61 in.-lb. (6.9 N•m) | 86 in.-lb. (9.8 N•m) |
| 5/16 | 115 in.-lb. (13 N•m) | 149 in.-lb. (17 N•m) | 178 in.-lb. (20 N•m) | 229 in.-lb. (26 N•m) | 250 in.-lb. (28 N•m) | 324 in.-lb. (37 N•m) | 125 in.-lb. (14 N•m) | 176 in.-lb. (20 N•m) |
| 3/8 | 17 ft.-lb. (23 N•m) | 22 ft.-lb. (30 N•m) | 26 ft.-lb. (35 N•m) | 34 ft.-lb. (46 N•m) | 37 ft.-lb. (50 N•m) | 48 ft.-lb. (65 N•m) | 19 ft.-lb. (26 N•m) | 26 ft.-lb. (35 N•m) |
| 7/16 | 27 ft.-lb. (37 N•m) | 35 ft.-lb. (47 N•m) | 42 ft.-lb. (57 N•m) | 54 ft.-lb. (73 N•m) | 59 ft.-lb. (80 N•m) | 77 ft.-lb. (104 N•m) | 30 ft.-lb. (41 N•m) | 42 ft.-lb. (57 N•m) |
| 1/2 | 42 ft.-lb. (57 N•m) | 54 ft.-lb. (73 N•m) | 64 ft.-lb. (87 N•m) | 83 ft.-lb. (113 N•m) | 91 ft.-lb. (123 N•m) | 117 ft.-lb. (159 N•m) | 45 ft.-lb. (61 N•m) | 64 ft.-lb. (88 N•m) |
| 9/16 | 60 ft.-lb. (81 N•m) | 77 ft.-lb. (104 N•m) | 92 ft.-lb. (125 N•m) | 120 ft.-lb. (163 N•m) | 130 ft.-lb. (176 N•m) | 169 ft.-lb. (229 N•m) | 65 ft.-lb. (88 N•m) | 92 ft.-lb. (125 N•m) |
| 5/8 | 83 ft.-lb. (112 N•m) | 107 ft.-lb. (145 N•m) | 128 ft.-lb. (174 N•m) | 165 ft.-lb. (224 N•m) | 180 ft.-lb. (244 N•m) | 233 ft.-lb. (316 N•m) | 90 ft.-lb. (122 N•m) | 127 ft.-lb. (172 N•m) |
| 3/4 | 146 ft.-lb. (198 N•m) | 189 ft.-lb. (256 N•m) | 226 ft.-lb. (306 N•m) | 293 ft.-lb. (397 N•m) | 319 ft.-lb. (432 N•m) | 413 ft.-lb. (560 N•m) | 160 ft.-lb. (217 N•m) | 226 ft.-lb. (306 N•m) |
| 7/8 | 142 ft.-lb. (193 N•m) | 183 ft.-lb. (248 N•m) | 365 ft.-lb. (495 N•m) | 473 ft.-lb. (641 N•m) | 515 ft.-lb. (698 N•m) | 667 ft.-lb. (904 N•m) | 258 ft.-lb. (350 N•m) | 364 ft.-lb. (494 N•m) |
| 1 | 213 ft.-lb. (289 N•m) | 275 ft.-lb. (373 N•m) | 547 ft.-lb. (742 N•m) | 708 ft.-lb. (960 N•m) | 773 ft.-lb. (1048 N•m) | 1000 ft.-lb. (1356 N•m) | 386 ft.-lb. (523 N•m) | 545 ft.-lb. (739 N•m) |

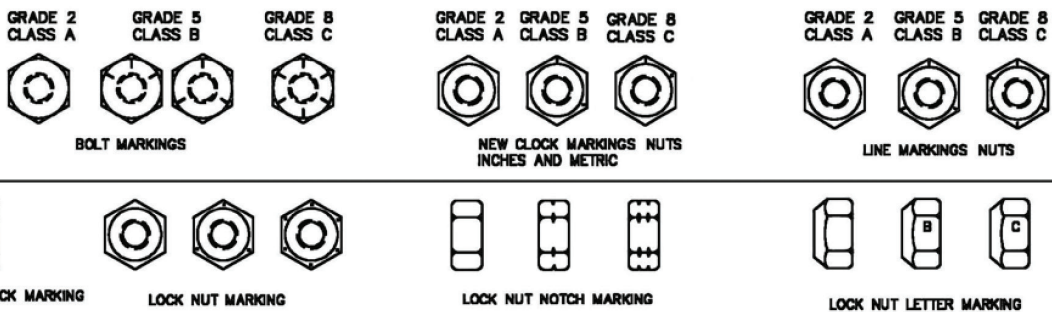

Torque Specifications (Cont'd)

Metric Hardware and Lock Nuts

TORQUE CHARTS
 Minimum Hardware Tightening Torques
 Normal Assembly Applications
 (Metric Hardware and Lock Nuts)

| Nominal Size | Class 5,8 | | Class 8,8 | | Class 10,9 | | Lock nuts |
|--------------|---------------------------|--------------------------|---------------------------|--------------------------|---------------------------|---------------------------|--------------------------|
| | Unplated or Plated Silver | Plated W / ZnCr Gold | Unplated or Plated Silver | Plated W / ZnCr Gold | Unplated or Plated Silver | Plated W / ZnCr Gold | Class 8 W / CL. 8,8 Bolt |
| M4 | 1.7 N•m (15 in.-lb.) | 2.2 N•m (19 in.-lb.) | 2.6 N•m (23 in.-lb.) | 3.4 N•m (30 in.-lb.) | 3.7 N•m (33 in.-lb.) | 4.8 N•m (42 in.-lb.) | 1.8 N•m (16 in.-lb.) |
| M6 | 5.8 N•m (51 in.-lb.) | 7.6 N•m (67 in.-lb.) | 8.9 N•m (79 in.-lb.) | 12 N•m (102 in.-lb.) | 13 N•m (115 in.-lb.) | 17 N•m (150 in.-lb.) | 6.3 N•m (56 in.-lb.) |
| M8 | 14 N•m (124 in.-lb.) | 18 N•m (159 in.-lb.) | 22 N•m (195 in.-lb.) | 28 N•m (248 in.-lb.) | 31 N•m (274 in.-lb.) | 40 N•m (354 in.-lb.) | 15 N•m (133 in.-lb.) |
| M10 | 28 N•m (21 ft.-lb.) | 36 N•m (27 ft.-lb.) | 43 N•m (32 ft.-lb.) | 56 N•m (41 ft.-lb.) | 61 N•m (45 ft.-lb.) | 79 N•m (58 ft.-lb.) | 30 N•m (22 ft.-lb.) |
| M12 | 49 N•m (36 ft.-lb.) | 63 N•m (46 ft.-lb.) | 75 N•m (55 ft.-lb.) | 97 N•m (72 ft.-lb.) | 107 N•m (79 ft.-lb.) | 138 N•m (102 ft.-lb.) | 53 N•m (39 ft.-lb.) |
| M16 | 121 N•m (89 ft.-lb.) | 158 N•m (117 ft.-lb.) | 186 N•m (137 ft.-lb.) | 240 N•m (177 ft.-lb.) | 266 N•m (196 ft.-lb.) | 344 N•m (254 ft.-lb.) | 131N•m (97 ft.-lb.) |
| M20 | 237 N•m (175 ft.-lb.) | 307 N•m (226 ft.-lb.) | 375 N•m (277 ft.-lb.) | 485 N•m (358 ft.-lb.) | 519 N•m (383 ft.-lb.) | 671 N•m (495 ft.-lb.) | 265 N•m (195 ft.-lb.) |
| M24 | 411 N•m (303 ft.-lb.) | 531 N•m (392 ft.-lb.) | 648 N•m (478 ft.-lb.) | 839 N•m (619 ft.-lb.) | 897 N•m (662 ft.-lb.) | 1160 N•m (855 ft.-lb.) | 458 N•m (338 ft.-lb.) |

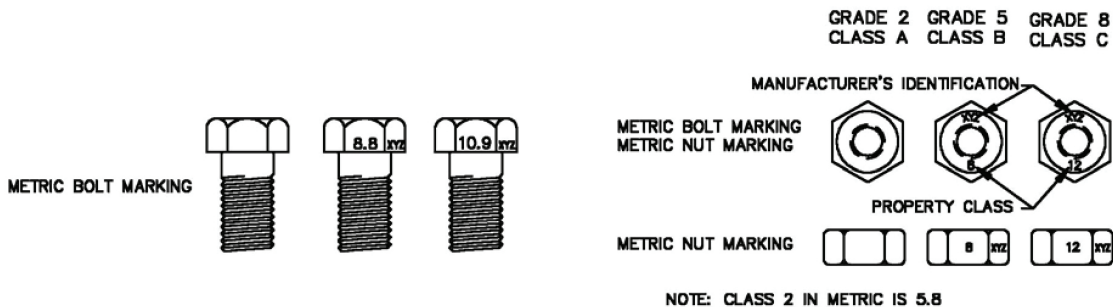



www.loftness.com

Loftness Specialized Equipment, Inc.
650 Main Street South • PO Box 337 • Hector, MN 55342
Tel: 320.848.6266 • Fax: 320.848.6269 • Toll Free: 1.800.828.7624

Printed in USA
© Loftness 2024